

PROLINE 50 REC



Linear luminaire made of extruded aluminum profile. High luminous efficacy optics with selection of diffusers. Direct lighting type. Top quality SMD LED modules with colour consistency MacAdams ≤ 3 , extensive portfolio of lumen ranges, CCTs and spectra. Variety of drivers: standard EVG on/off, DALI and wireless controlled as MasterConnect or Casambi on request. Built-in or remote, wireless occupancy & daylight sensor available to allow significant energy savings and wireless connectivity. Mounting type: recessed into plasterboard ceiling. Standard colour RAL 9003S, any other colour from basic RAL range available at no extra cost. Variety of diffusers, lumen outputs and drivers allows to use this luminaire in different types of lighting projects. Wide selection of standard lengths: single linear luminaires (type S) or system luminaires (type SE/M) and system connectors (L,T,X type). Many lengths of lighting lines, square and rectangular shapes can be created by using our system pieces. End caps for single (S type) profiles included. All accessories such as end caps, linear connectors or quick connectors for system profiles (SE/M type) should be ordered separately. Bespoke lengths and shapes of lighting lines available on request.

Luminous flux & Luminaire Power tolerance up to 10%. System power consumption depends on components used. Luminous efficacy depends on type of LED's, electronics, optics and diffuser. The most up to date technical parameters can be found on our website and in database of LDT files.

Lighting direction:



PDF datasheet:



PROLINE 50 REC

Mounting:	Recessed mounting
Body material:	Aluminium profile
Colour:	Standard white RAL 9003M, other RAL colours on request
Lumen output:	Standard up to 4000 lm/meter, any other on request
LED module:	Signify (Philips), Tridonic or equivalent SMD LED modules
Colour temperature:	3000/4000K/2700-6500K TW other on request
Colour Rendering:	CRI>80 in standard, other on request
Driver:	EVG on-off/DALI/TW DT8/MC (MasterConnect)/Casambi, other on request
Wireless control:	Philips MasterConnect / Casambi, other on request
Daylight/Occupancy sensor:	Built-in XC sensor or wireless MCS sensor
Emergency unit:	On request
Operating temperature range:	0°C ... +35°C
IP Class:	IP20 in standard
Power:	220-240V 50/60Hz
Lighting direction:	Direct lighting
Light distribution:	Symmetric
Diffusor:	OP white acrylic / MP19H microprismatic UGR<19
Optics:	White reflector
Beam angle:	All types available in our LDT file database
Warranty:	5 Years standard warranty

- PROLINE 50 REC S DN** single profile, ceiling recessed, light down, OP or MP19H diffusor
- PROLINE 50 REC SE DN** system profile START/END type, ceiling recessed, light down, OP or MP19H diffusor
- PROLINE 50 REC M DN** system profile MIDDLE type, ceiling recessed, light down, OP or MP19H diffusor
- PROLINE 50 REC L / T / X DN** system profile L/T/X type, ceiling recessed, light down, OP or MP19H diffusor



Energy saving MasterConnect wireless lighting control system with daylight and movement detection technology on request.



All current index numbers, lumen outputs, power consumption and many other technical information are available in our 2024 pricelist. Details on wireless lighting control systems on page number 896.



XCS wireless switch



MCS wireless daylight&occ sensor



XC daylight&occ sensor

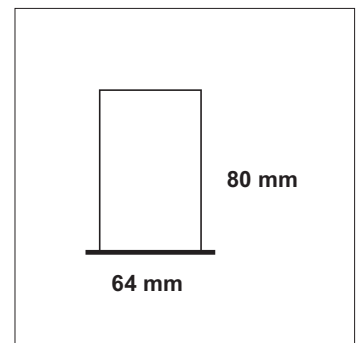

Basic dimensions

PROLINE 50 REC



OP white acrylic diffuser

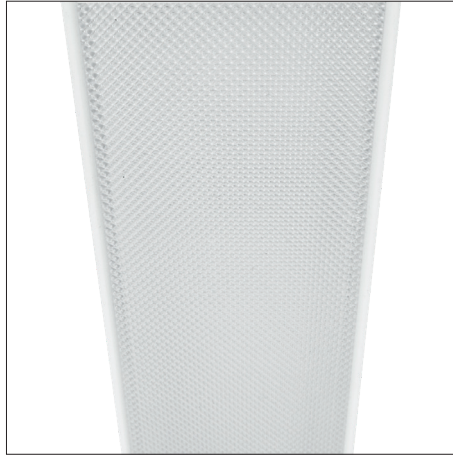

MP19H microprismatic diffuser

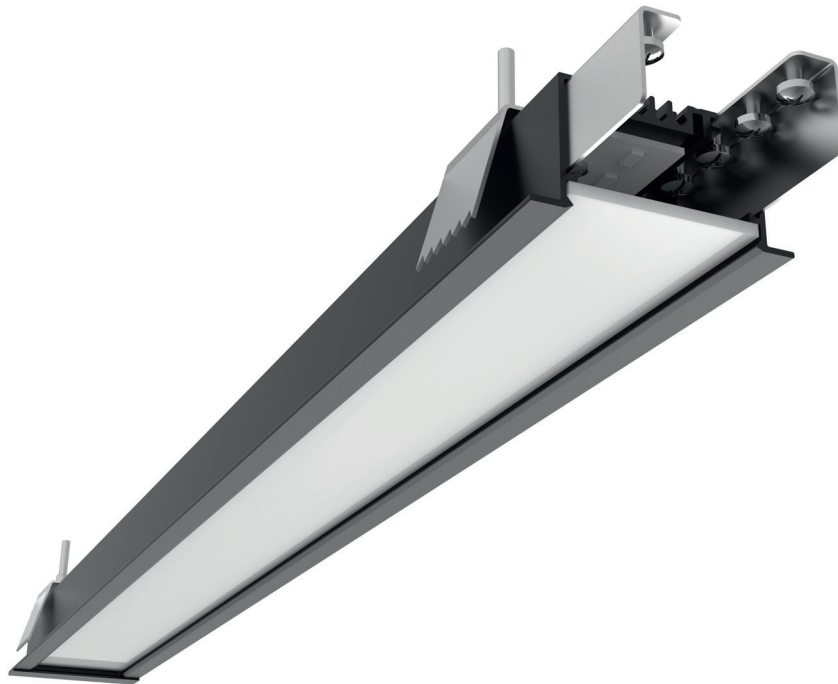

All PROLINE type luminaires can be made to measure as single lighting lines or lighting systems in different sizes and shapes. Please contact our sales team for details.

Mounting types:



PROLINE 50 REC

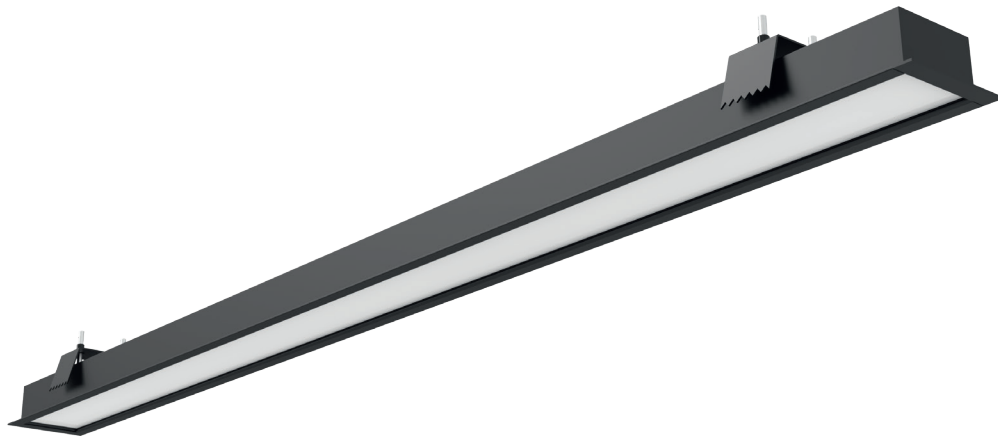

Accessories



3 pole quick connectors (Male + Female)



5 pole quick connectors (Male + Female)



PROLINE 50 REC end cap



PROLINE 50 linear connector

Couplers

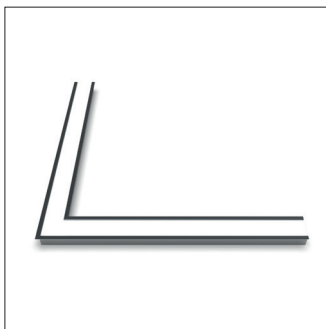

PROLINE 50 REC system coupler type L DN

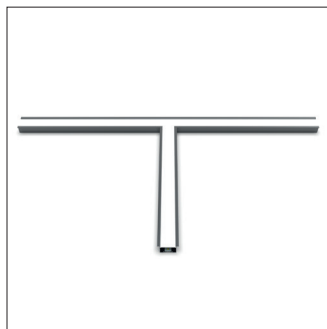
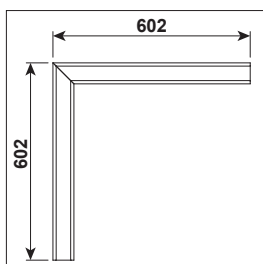

PROLINE 50 REC system coupler type T DN

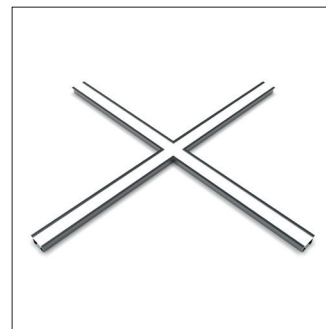
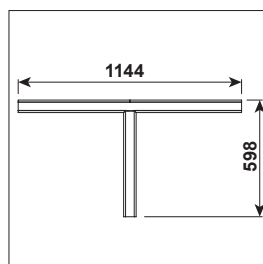

PROLINE 50 REC system coupler type X DN

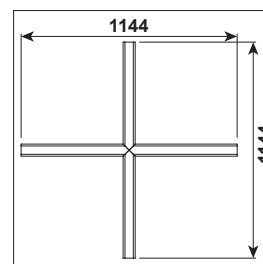

PROLINE 50 REC

Profile types:

Single profile versions:

TYPE S DN single profile, light down



MOUNTING OPTIONS:
light down, recessed

System profile versions:

TYPE SE DN system profile, start/end section, light down



MOUNTING OPTIONS:
light down, recessed

TYPE M DN system profile, middle section, light down



MOUNTING OPTIONS:
light down, recessed

PROLINE 50 REC

Single profile, standard lengths including end caps TYPE S DN (cutout length without endcap lip):

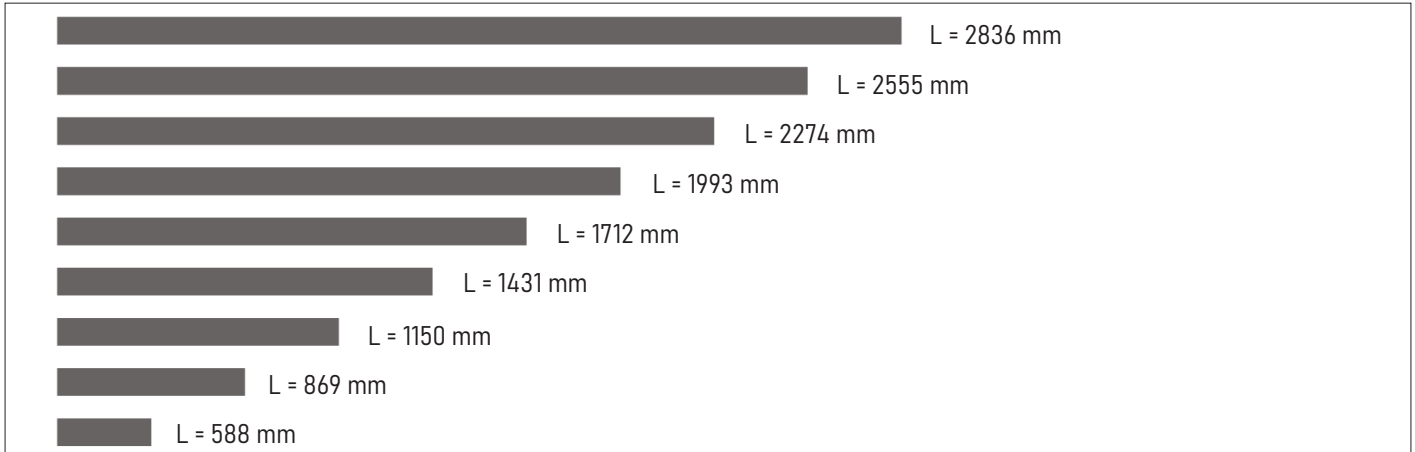

System profile, start/end section lengths including one end cap TYPE SE DN:

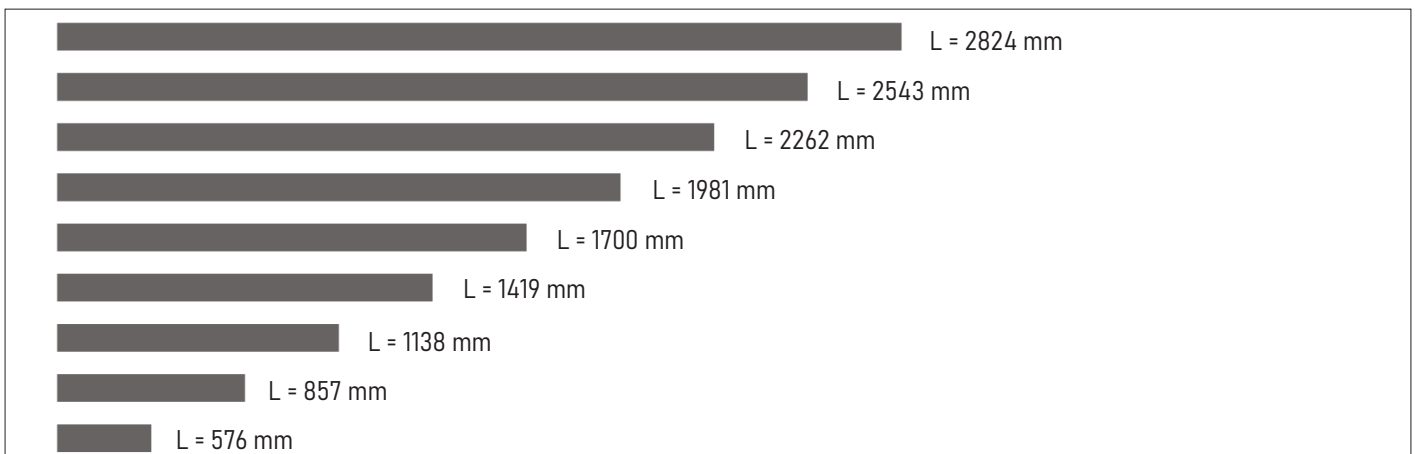

System profile, middle section lengths TYPE M DN:

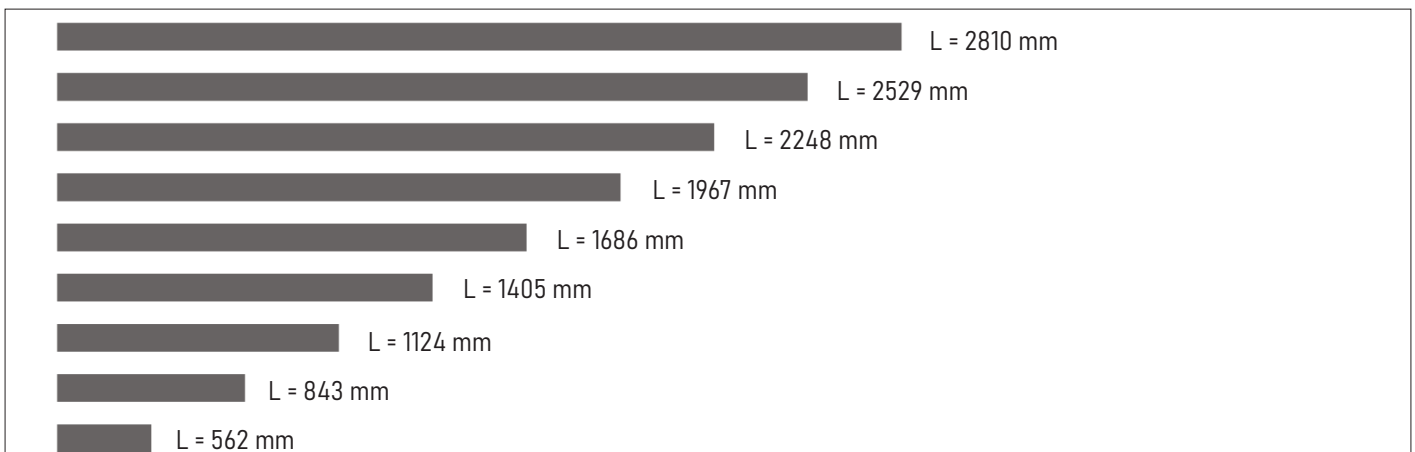

PROLINE 50 REC

DESCRIPTION OF PROLINE CONCEPT:

- PROLINE S DN - single luminaires with light down (can't be connected into lighting systems)
- PROLINE SE DN - system luminaire with light down (must be used at the beginning and at the end of each linear lighting system)
- PROLINE M DN - system luminaire with light down (middle section to be used in between SE type profiles). Any length of lighting system can be created by using different lengths and numbers of M-type profiles between two SE-type profiles.

PROLINE S

PROLINE SE PROLINE SE

PROLINE SE PROLINE M PROLINE SE

PROLINE SE PROLINE M PROLINE M PROLINE M PROLINE SE

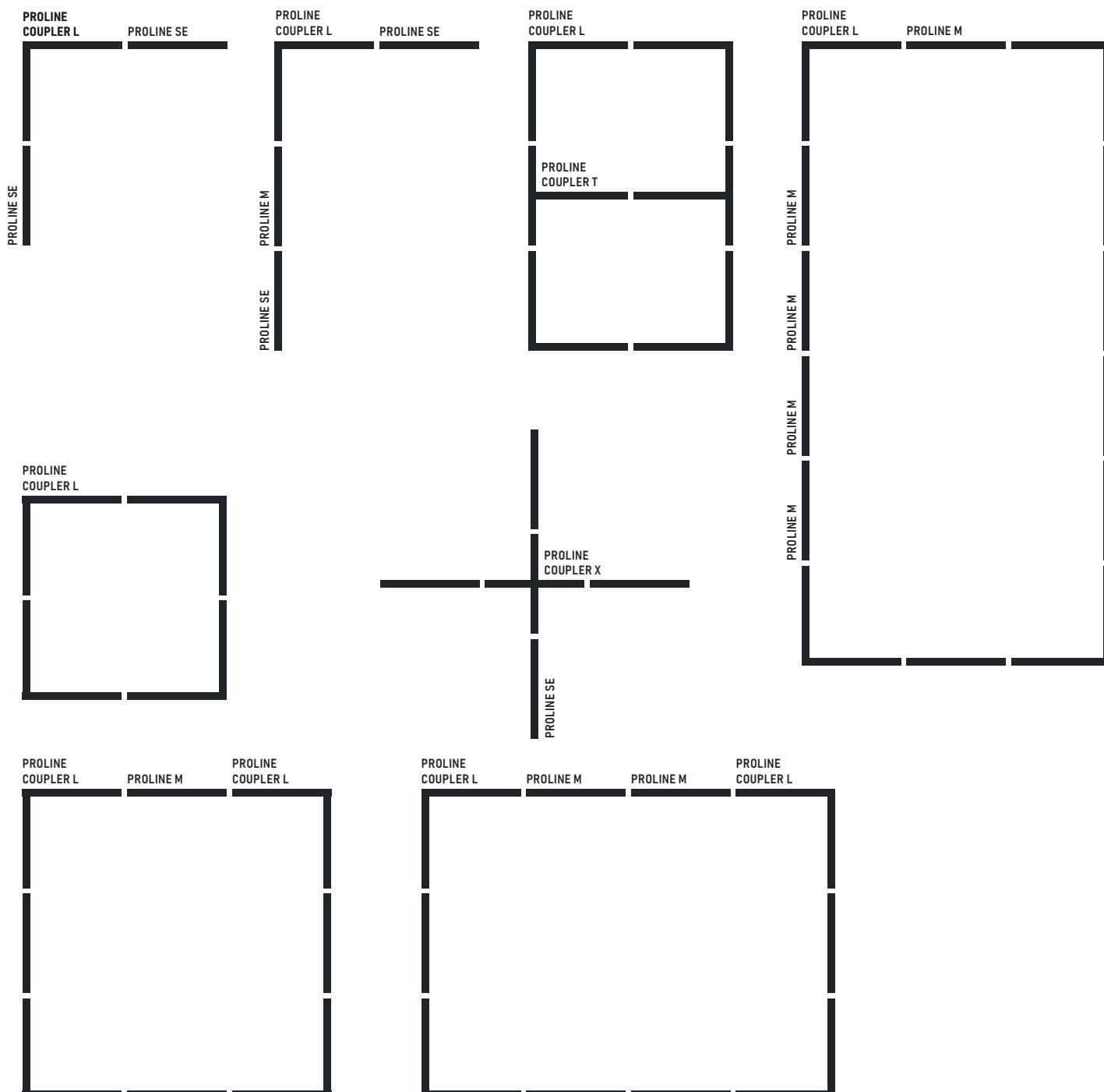

PROLINE 50 REC

PROLINE CONCEPT - HOW TO BUILD LIGHTING SYSTEMS:

- Always start your linear lighting system with SE type of PROFILE
- Use required number of M type PROFILES to extend length of your lighting system
- Always finish your linear lighting system with SE type of PROFILE
- COUPLERS T, X and L type can be used to modify your lighting system design
- Each end of T, X or L COUPLER must be connected further to M or SE type of PROFILE.
- End of COUPLER can't be closed with end cap directly.
- Remember - PROLINE M can't exist on its own without additional SE type of PROFILES.
- Available length of PROLINE elements (SE/M can be found on corresponding pages in our catalogue)
- All accessories such as end caps, linear connectors or quick connectors should be ordered separately for all types of system profiles: Type SE / M / L / X / T.

